

envirovent®

Cyclone 8

Designed to Perform. Built to Last.

WC. Bathroom & Kitchen Fan



cyclone⁸

8
YEAR
WARRANTY

Unrivalled
eight year
warranty
as standard





cyclone⁸



Helps **Reduce**...



Condensation



Mould

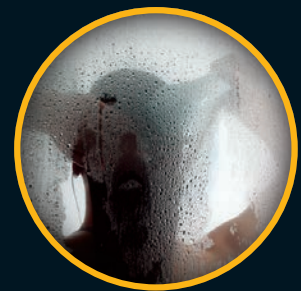

High Humidity

The Cyclone 8 is a major advancement in extract fan technology, designed to deliver high performance in controlling humidity levels in kitchens, bathrooms and utility rooms using the lowest energy consumption.

- › Datalogging function as standard.
- › Variable speed control.
- › Meets the required regulations & standards.
- › Patented cyclone separation technology.
- › Rapid & safe cleaning. No filters. No fuss.
- › Truly unique exchangeable cartridge system.
- › Intellitrac[®] vapour tracking to control condensation.
- › Ultra low energy consumption.
- › Whisper quiet running.

Features & Benefits



Just some of the reasons why you should choose the Cyclone 8



Patented cyclone separation technology
For maximum performance to control moisture and humidity



Cyclone IQ controls
Remote controlled boost option

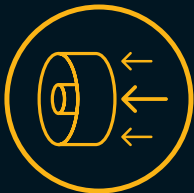

Removable impeller. No filter.
For hassle-free, rapid and safe cleaning



Whisper quiet running
Eliminates one of the biggest complaints about noisy fans



Exchangeable cartridge system
You never need to buy a new extract fan again



Automatic variable speed setting
The Cyclone 8 automatically adjusts the fan speed to suit its current environment



Ultra low energy consumption
Long trouble free life, less costs



Manufactured in the UK
Supporting our local economy, lowering the carbon footprint



Intellitrac® humidity tracking control
No need for user intervention, the Cyclone 8 reacts quietly to reduce high humidity before condensation can start to occur



8 year renewable warranty*
High quality for peace of mind, saving time, money and hassle. Reducing the impact on landfill sites, and even includes the cartridge



Datalogging function
Enables the collection of data such as the total running time at both speeds, the time in which the fan has spent in periods of increased humidity and the energy that has been used



Variable speed control
Ability to vary the speed of the fan for more control and to reach increased airflows

*Unit must be in warranty during service and cartridge change.



Cyclone Separation Technology

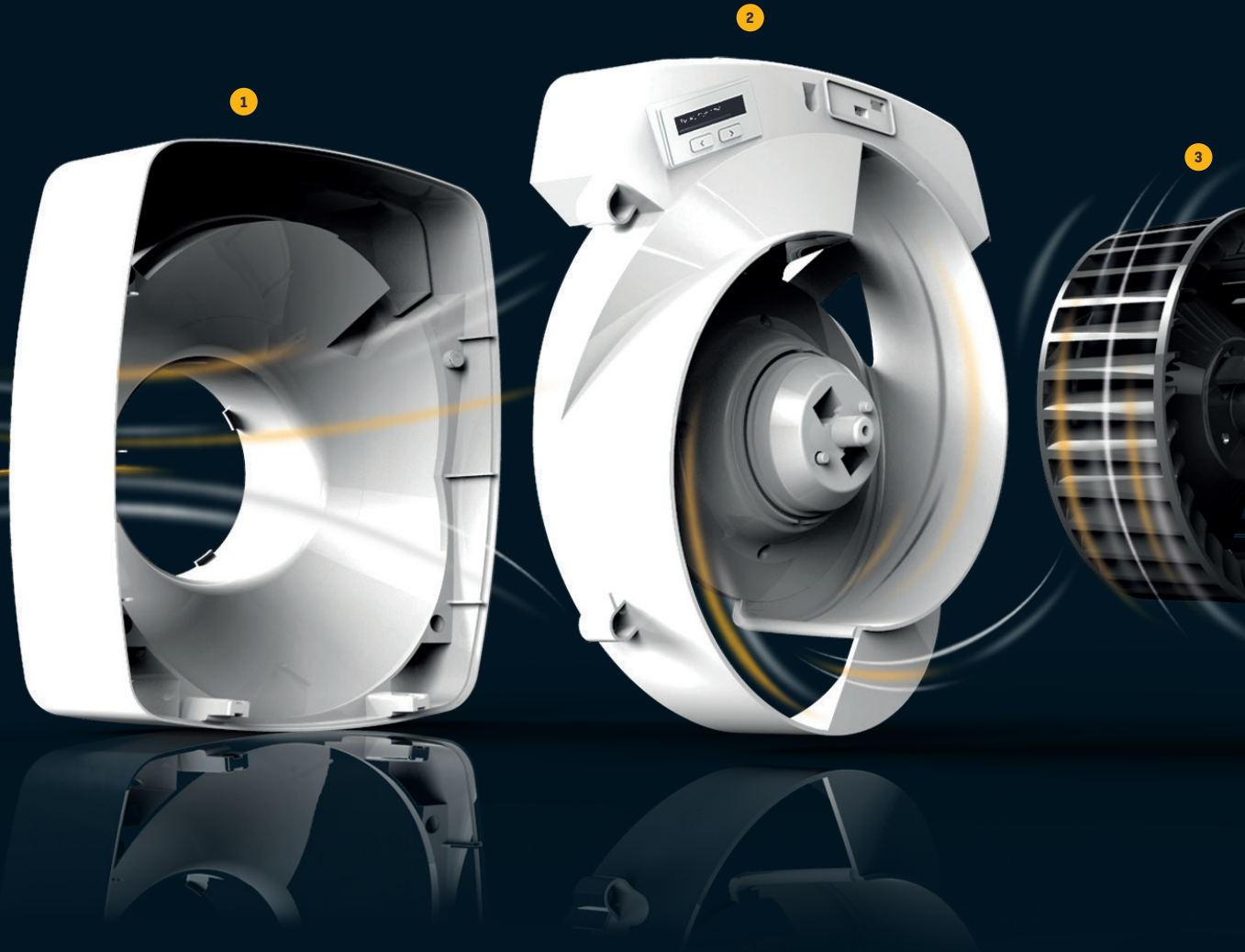

accept no imitations.

As the moisture-laden and contaminated air passes through the front grille, it is thrown outwards into two expansion chambers. These allow the air to expand directly out to atmosphere, quietly extracting out the airborne contaminants. As no filters are required, air can be extracted out quietly, without risk of causing clogged, unhygienic filters that result in increased noise and low performance.



cyclone

Separation **Technology**

The Cyclone 8 ensures that particles, humidity and dust in the air are drawn into the fan and extracted outside the property, without the need for filters that can become clogged. This enables the fan to deliver the maximum of performance to control moisture and humidity using the lowest energy consumption.

- 1 Back carcass which remains in-situ for the life of the property
- 2 Exchangeable and recyclable centrifugal cartridge
- 3 Unclippable impeller
- 4 Front cover

Compare this with traditional extract fans where the air takes a tortuous route through the fan causing high resistance, noise and contaminants to stick to the fan, clogging the filter, motors and controls. Cyclone separation has been used for decades in saw mills all over the world where the technology performs in the most rigorous of environments over long term periods with no filters and no reduction in performance.

The Cyclone 8 has been manufactured in the UK, designed to provide high performance extract ventilation, controlling humidity levels, removing moisture and improving indoor air quality for the long term.



No Filters No Fuss

For all situations

The Cyclone 8 is ideal for WC, bathroom, kitchen and utility room installations, delivering high performance extract ventilation to meet the building regulations and beyond.

From simple through the wall installations, to inline, window and ceiling installations, the Cyclone 8 fan fits all with the use of easy to install accessory kits.

For extra safety in bathrooms, a low voltage version is available.

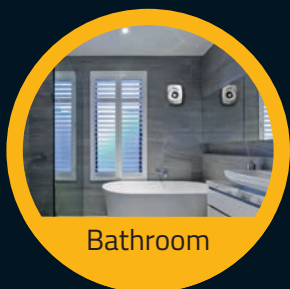
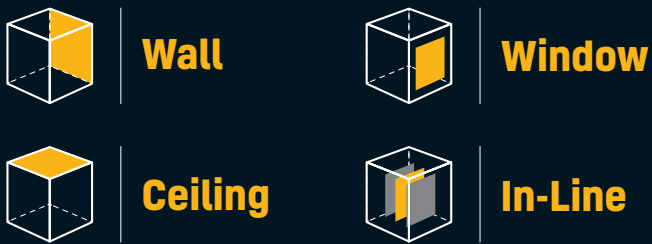

Easy cleaning

The Cyclone 8 has been designed with ease of cleaning and servicing in mind. That is why it can be carried out safely and hassle-free by the resident. There is a small magnet which deactivates the fan as soon as the front cover is removed.

The front cover and impeller can then be cleaned in a sink and the fan scroll can be wiped clean with a cloth quickly and easily.

Once the impeller is inserted again and the front cover replaced, the fan will continue to run as normal.

The diagram shows the cleaning steps in four numbered stages: **1** Remove Cover, **2** Unclip Impeller, **3** Clean & Replace, and **4** Clean & Replace. The final step is labeled as '3 Clean & Replace' in the table below.

| Cleaning Steps | |
|----------------|-----------------|
| 1 | Remove Cover |
| 2 | Unclip Impeller |
| 3 | Clean & Replace |



Datalogger & variable speed control as standard

Built into the central cartridge the Cyclone Datalogger comes as standard enabling landlords to monitor running conditions, energy and operational life.

Also as standard is the variable speed control which enables the fan speed to be altered to ensure regulatory compliance.

Ventilation Made Simple

Easy servicing

All servicing and repair takes place in an instant by simply exchanging the plug out/plug in central cartridge. The old one can then be returned to the factory to be recycled or reworked.

There are no redecoration issues or wiring alterations and the basic fan installation remains intact for the lifetime of the property.

Providing that the fan is in warranty, this is then reinstated with another 8 year warranty, avoiding thousands of tonnes of plastics ending up on our fast overflowing landfill sites.

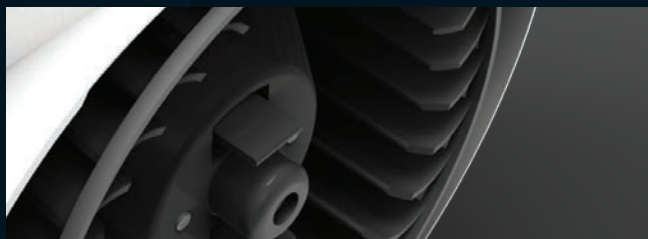
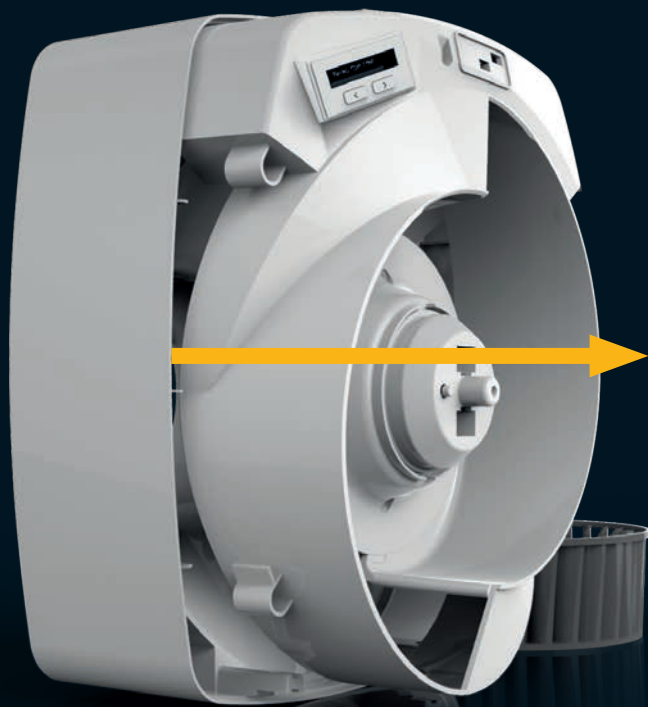

Intellitrac[®] vapour tracking

Incorporated within the Cyclone 8 is the intelligent vapour tracking control, which constantly monitors the humidity level.

As humidity rises and falls, the motor speed rises and falls in direct correlation.

This controls condensation quietly and efficiently, eliminating the problem of noisy extract fans and reducing the periods of time when the fan operates on maximum speed, saving energy.

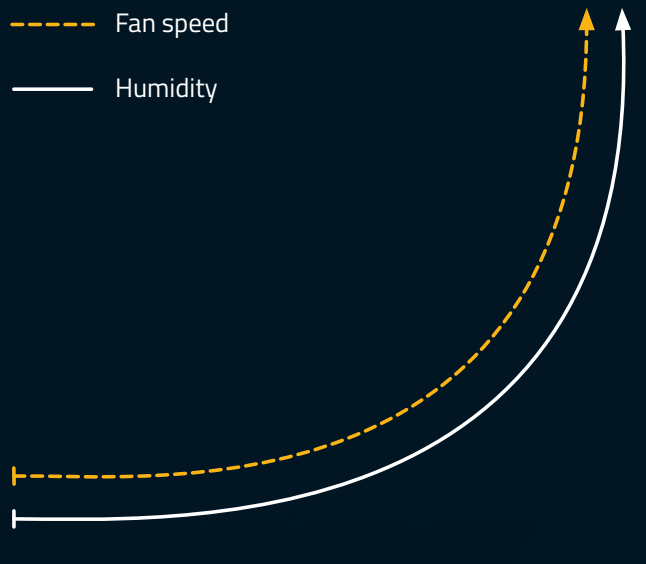

Remote Controllable

Remote controllable

The fan operates continuously at a low rate known as 'trickle' to ensure that your kitchen or bathroom is ventilated at the appropriate level. The Cyclone 8 will automatically vary its extract rate when it senses an increase in the moisture level running through the fan.

The Cyclone 8 IQ version is supplied with a remote control for boost operation offering ultimate control to the user.

Pressing the button once on the remote control, the unit will go into boost mode. The boost time is set to 15 minutes.



cyclone^{IQ}



Technical data

Dimensions (mm)

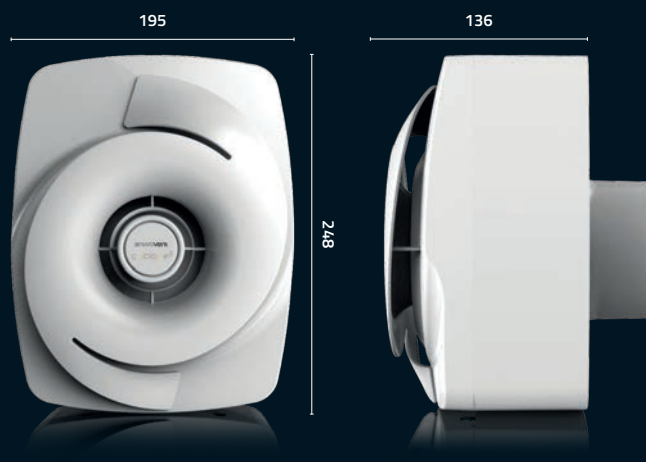

Order codes

| MODELS | DESCRIPTION |
|----------------|----------------------------------|
| CYC-DL-230V | Cyclone 8 |
| CYC-DL-SELV | Cyclone 8 SELV SELV |
| CYC-DL-IN-IQ | Inline with IQ control |
| CYC-DL-230V-IQ | 230V with IQ control |
| CYC-DL-SELV-IQ | SELV with IQ control SELV |

Accessories

| MODELS | DESCRIPTION |
|--------------|-----------------------------|
| EFWAK | Wall kit |
| EFCMBR | Ceiling mounting kit |
| CYC-230V-WIK | 230V window kit |
| CYC-SELV-WIK | SELV window kit SELV |

Running costs Bathroom & Kitchen

Please scan our QR code to see the annual running costs of this product.



Or visit: envirovent.com/annual-running-costs



Remote Controllable

envirovent

envirovent®

Leaders in the manufacture of innovation
and sustainable ventilation

EnviroVent Ltd
Harrogate West Business Park
Unit 1 Bardner Bank
Killinghall, Harrogate
HG3 2SP

T / 01423 810 810
E / enquiries@envirovent.com
W / www.envirovent.com

Due to our policy of continuous innovation and improvement, EnviroVent reserves the right to alter products specification and appearance without notice.

E&OE | MKT ENV1023 - V5 - 21/03/2025



Follow us on
facebook



Watch us on
Youtube



Follow us on
Instagram

